

Signet 2751 DryLoc® pH/ORP Smart Sensor Electronics



In-line
2751-1

In-line EasyCal
2751-2

Submersible
2751-3 or 2751-4

DryLoc® Electrodes sold separately

The Signet 2751 pH/ORP Smart Sensor Electronics featuring the DryLoc® connector, is the solution for field-free calibration, out of range glass impedance and broken glass detection, alerting the operator to probe failure or maintenance needs.

The 2751 features two different outputs: a two-wire 4 to 20 mA loop output with optional EasyCal function or a digital (S³L) output which allows for longer cable lengths and is compatible with all Signet 8900, 9900 and 9950* instruments or in blind, 4 to 20 mA.

The Smart Sensor Electronics will allow for calibration of electrodes in a laboratory setting and installation of pre-calibrated probes in the field, reducing system downtime. Memory chip enabled electrodes will store operational data such as minimum and maximum pH/mV readings, runtime, minimum and maximum temperature (pH only), for troubleshooting and operational evaluation. To take full advantage of all features and benefits of the 2751, use with Signet 9900 (Generation IV or later), 9950 Transmitter or 0486 Profibus Concentrator.

The 2751 self-configures for pH or ORP operation via automatic recognition of the electrode type. The optional EasyCal feature allows simple push-button calibration and includes an LED indicator for visual feedback.

The 2751 submersible Smart Sensor Electronic can also be used in-line when used with the 3/4" or 1" threaded sensors including the 272X, 273X, 275X, 276X and 277X series of electrodes. The 2751 in-line sensor electronics can be used with Signet fittings up to DN100 (4 in.) and Wet-Tap assemblies.

Features

- Probe health monitoring, glass impedance and broken glass detection
- Memory chip interface that allows for transferable calibration, runtime data, and manufacturing information
- In-line integral mount and submersible installation versions
- Automatic temperature compensation
- Auto configuration for pH or ORP operation
- Optional EasyCal calibration aid with automatic pH buffer recognition for 4, 7 and 10 pH and ORP solutions: quinhydrone saturated pH 4 or 7 buffers and Light's Solution +469 mV
- Junction boxes for convenient wiring
- Patented DryLoc® connector provides a quick and secure connection to the sensor**



Applications

- Water and Wastewater Treatment
- Neutralization Systems
- Scrubber Control
- Effluent Monitoring
- Surface Finishing
- Flocculent Coagulation
- Heavy Metal Removal and Recovery
- Toxics Destruction
- Sanitization Systems
- Pool & Spa Control
- Aquatic Animal Life Support Systems

*Users of 9950 Gen I and 9950 (Gen 2a) should update to 9950 (Gen 2b, available in Q4) to take full advantage of the 2751 features and benefits. Visit www.gfsignet.com for the latest software update.

**U.S. Patent No.: 6,666,701

Specifications

General

Compatible Electrodes

Signet DryLoc® pH and ORP Electrodes, Models 2724-2726, 2734-2736, 2756-2757 Wet-Tap, 2764-2767, 2774-2777

Operating Range	pH	-1 to 15 pH
	ORP	±2000 mV
Response Time	pH	< 6 sec. for 95% of change
	ORP	Application dependent
Materials	In-line	PBT (thermal plastic polyester) and polypropylene (retaining nut)
	Submersible	CPVC

Electrical

Cable	4.6 m	15 ft	3-conductor shielded (3-2751-1 in-line and the 3-2751-3 or -4 submersible sensor electronics only)	
	22 AWG		For 9900, 9950 and 4 to 20 mA max. cable length is 300 m (1000 ft.). For 8900, please refer to the Cable Calculation Table of the Signet catalog for max. cable length.	
Power	12 to 24 VDC		±10%, regulated for 4 to 20 mA output	
	5 to 6.5 VDC		±5% regulated recommended, 3 mA max., for digital (S ³ L) output	
Current Output	pH		Fixed 4 to 20 mA, isolated, = 0 to 14 pH (custom scaling available with 0252 tool)	
	ORP		Fixed 4 to 20 mA, isolated, = -1000 to +2000 mV (custom scaling available from ± 2000 mV with 0252 tool)	
Max Loop Resistance	100 Ω max. @ 12 V	325 Ω max. @ 18 V	600 Ω max. @ 24 V	
Accuracy	±32 µA			
Resolution	±5 µA			
Update Rate	0.5 seconds			
Error Indication	3.6 mA, 22 mA, or none			
Digital (S ³ L) Output	Serial ASCII, TTL level 9600 bps			
Accuracy	pH	± 0.02 pH @ 25 °C	± 0.02 pH @ 77 °F	
	ORP	± 1.5 mV @ 25 °C	± 1.5 mV @ 77 °F	
	Temperature	≤ 0.4 °C	0.72 °F	
Resolution	pH	≤ 0.01 pH		
	ORP	1.5 mV		
Update Rate	0.5 seconds			
Available Data	Raw mV, pH or ORP, Temperature (pH), Glass Impedance (pH), Minimum mV (pH), Maximum mV (pH), Minimum Temperature (pH), Maximum Temperature (pH), Model Number, Serial Number, Manufacturing Date, Runtime, Slope pH/mV, Measurement Offset, and Temperature			
Error Indication	Open input diagnostic, broken glass detection (pH), High Impedance			
Input Impedance, Z	>10 ¹¹ Ω			

Environmental

Enclosure	3-2751-1 & -2	NEMA 4X/IP65 with electrode connected
	3-2751-3 & -4	NEMA 6P/IP68 with electrode and watertight conduit and/or extension pipe connected

Max. Temperature/Pressure Rating

Operating Temperature

Submersible	0 °C to 85 °C	32 °F to 185 °F
	0 °C to 85 °C	32 °F to 185 °F
In-line	0 °C to 85 °C	32 °F to 185 °F
Storage Temperature	-20 °C to 85 °C	-4 °F to 185 °F
Relative Humidity	0 to 95%, non-condensing (without electrode connected)	

Shipping Weight

2751-2	0.75 kg	1.65 lb
2751-1, -3 & -4	0.64 kg	1.41 lb

Standards and Approvals

CE, FCC
RoHS compliant, China RoHS
Manufactured under ISO 9001 for Quality and ISO 14001 for Environmental Management and OHSAS 18001 for Occupational Health and Safety

Dimensions

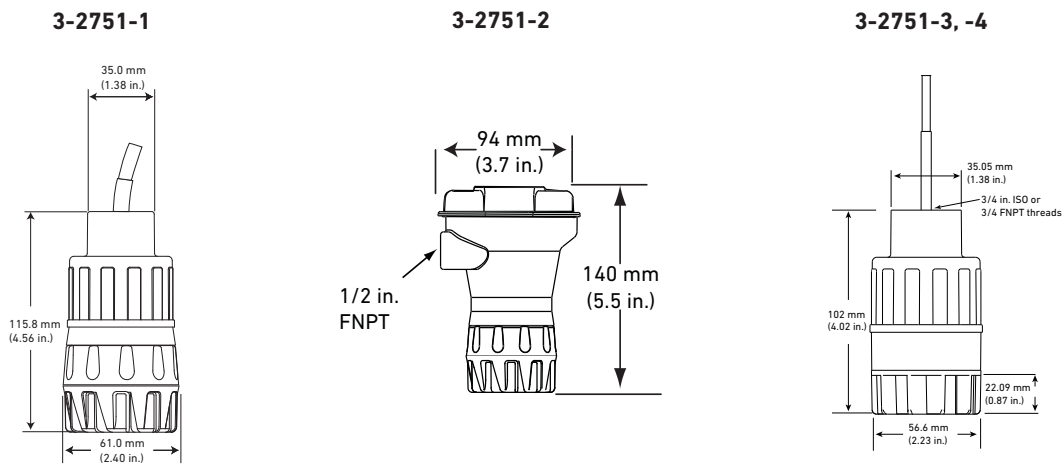

In-Line Installation

Panel Mount	Pipe, Tank, Wall	4 to 20 mA Input	Automation System
Signet Instruments 8900 9900 9950 	Signet Instrument 9900 and Rear Enclosure 	3-2751 Smart Sensor Electronics and Customer Supplied Chart Recorder, Programmable Logic Controller, or Programmable Automation Controller 	3-0486 Profibus Concentrator and Customer Supplied Programmable Logic Controller or Programmable Automation Controller
Signet 2751 Smart Sensor Electronics 	Signet 2751 Smart Sensor Electronics with Signet 3-8050-2 Universal Junction Box (EasyCal) 	Signet 2751 Smart Sensor Electronics 	
Signet Electrodes 2724-2726 2734-2736 2764-2767 2774-2777 		2724-2726 and 2734-2736 DryLoc Electrodes: Use GF fittings* or customer supplied 3/4 in. NPT fittings 2764-2767 and 2774-2777 DryLoc Electrodes: Use customer supplied 3/4 in. or 1 in. NPT fittings All sold separately	

System Overview

Submersible Installation













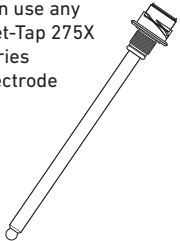
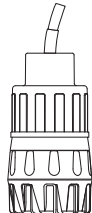
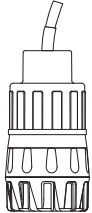

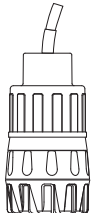
Wet-Tap Installation

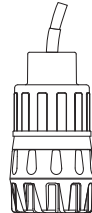
Panel Mount	Pipe, Tank, Wall	4 to 20 mA Input	Automation System
Signet Instruments 8900 9900 9950 	Signet Instrument 9900 and Rear Enclosure 	2751 Smart Sensor Electronics and Customer Supplied Chart Recorder, Programmable Logic Controller, or Programmable Automation Controller 	0486 Profibus Concentrator and Customer Supplied Programmable Logic Controller or Programmable Automation Controller
Signet 2751 Smart Sensor Electronics with customer supplied pipe extension or conduit, 3/4 in. NPT or ISO 7/1-R 3/4 threads** 	Signet 2751 Smart Sensor Electronics with Signet Wet-Tap Electrode 2756, 2757 and Signet 3719 Wet-Tap 		
Signet Electrodes 2724-2726 2734-2736 2764-2767 2774-2777 		GF Tees and Fittings see model 3719 for more info 	
All sold separately			

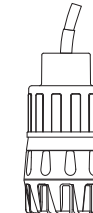
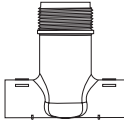
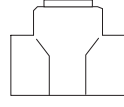
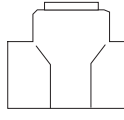
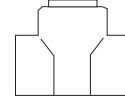
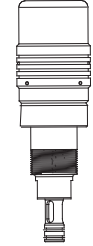
* See fittings section for more information.

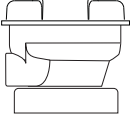
**Refer to the Signet Submersion Kit brochure (3-0000.707) located on our website for installation suggestions and options.

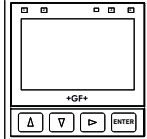
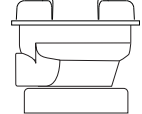
2751 Product Selection Guide

<p>1. Choose the Electrode</p>	<p>2724-2726, 2734-2736</p> <p>Can use Any 3-272X or 273X series Electrode</p> 	<p>2764-2767 Differential</p> <p>3-2764-1 3-2764-2 3-2766-1 3-2766-2</p> 	<p>2774-2777</p> <p>ORP electrodes must have 10K ID resistor use: 3-2775, 3-2777</p> <p>pH Electrodes can be either the 1K or 3K use: 3-2774, 3-2774-1, 3-2776, 3-2776-1</p> 	<p>2756 and 2757 Wet-Tap</p> <p>Can use any Wet-Tap 275X series electrode</p> 	
<p>2. Determine the mounting style:</p>	<p>In-line</p>  <p>2751-1 or -2</p>	<p>In-line</p>  <p>2751-1 or -2</p>  <p>2751-3 or -4</p>	<p>In-line</p>  <p>2751-1 or -2</p>  <p>2751-3 or -4</p>	<p>In-line</p>  <p>2751-1 or -2</p>  <p>2751-3 or -4</p>	<p>In-line</p>  <p>2751-1 or -2</p> <p>-In-line fitting</p>  <p>Signet fitting</p>  <p>3/4" reducing tee</p>  <p>1" threaded tee</p>  <p>3/4" reducing tee</p> <p>Submersible</p> <p>2751-3 or -4 and cable conduit (customer supplied) connected to 3/4" sensor electronics</p>  <p>+</p>  <p>3719 Wet-Tap Assembly</p> <p>(Submersible not applicable with Wet-Tap assembly)</p>
<p>3. Junction Boxes</p>	<p>3-8050-1: Use when extending the submersible cable over long distance.</p> <p>3-8050-2: Use with the submersible 2751-3 or -4 and the in-line 2751-1 for best calibration results with the EasyCal function when using the blind 4 to 20 mA output.</p>				
<p>4. Choose the output instrument</p>	<p>Digital (S^L)</p>    <p>OR</p>   <p>4 to 20 mA</p> <p>9900 or 9950 Instruments, Profibus Concentrator</p> <p>PLCs or Chart Recorders</p>				

Model 2751 Ordering Information

- 1) Model 2751 requires 12 to 24 VDC to function as a blind 4 to 20 mA output transmitter.
- 2) Order a 3-2751-2 or any other 2751 with a junction box 3-8050-2 if the EasyCal feature is desired.
- 3) Conduit and mounting brackets for submersion installation must always be used (customer supplied).
- 4) The 3-2759 System Tester must be ordered with the adapter cable 3-2759.391 for exclusive use with the 2751.
- 5) All sensor electronics, preamplifiers and connectors require a DryLoc electrode for full system installation.
- 6) The 2751 Smart Sensor Electronics is compatible with all Signet 8900, 9900 and 9950 instruments. To take full advantage of the advanced features use the 9900 SmartPro Transmitters (Generation IV or greater), 9950 and 0486 Profibus Concentrator.

Application Tips

- The EasyCal feature automatically recognizes standard 4.0, 7.0, and 10.0 pH buffer or ORP quinhydrone solutions of +87 and +264 mV or Light's Solution, +469 mV, and simplifies calibration. For EasyCal ORP only single point calibration is used.
- Frequency of calibration of electrodes is dependent upon the application.

Ordering Information

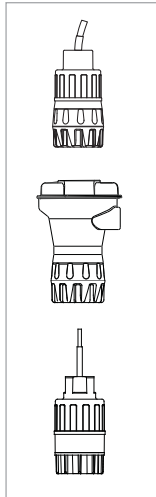

Mfr. Part No.	Code	Description
In-line Smart Sensor Electronics (Yellow body)		
3-2751-1	159 001 804	with 4.6 m (15 ft) cable, recommended for 9900 or 9950 instruments
3-2751-2	159 001 805	with junction box and EasyCal, recommended for 4 to 20 mA use
Submersible Smart Sensor Electronics (Gray body)		
3-2751-3	159 001 806	with 4.6 m (15 ft) cable and 3/4 in. NPT threads - when 4 to 20 mA is required use the 3-8050-2 junction box with EasyCal
3-2751-4	159 001 807	with 4.6 m (15 ft) cable and ISO 7/1-R 3/4 threads - when 4 to 20 mA is required use the 3-8050-2 junction box with EasyCal

Sensor Electronics with preamplified signal and Digital (S³L) output (for use with the SmartPro Instruments) or 4 to 20 mA output - power supplied to unit dictates output type.

Note:

The 2751 Smart Sensor Electronics is compatible with 8900, 9900 and 9950 SmartPro Transmitters, and Signet 0486 Profibus Concentrator. To take full advantage of the 2751 features, use 9900 (Generation IV or later), 9950 or 0486 Profibus Concentrator.

Accessories and Replacement Parts

Mfr. Part No.	Code	Description
Calibration		
3-2700.395	159 001 605	Calibration kit: includes 3 polypropylene cups, box used as cup stand, 1 pint pH 4.01, 1 pint pH 7.00
3822-7115	159 001 606	20 gm bottle quinhydrone for ORP calibration (must use pH 4.01 and/or pH 7.00 buffer solutions)
3-2759	159 000 762	pH/ORP system tester (adapter cable sold separately)
3-2759.391	159 000 764	2759 adapter cable for use with 2751 DryLoc sensor electronics
3-0700.390	198 864 403	pH buffer kit (1 each 4, 7, 10 pH buffer in powder form, makes 50 ml of each)
3822-7004	159 001 581	pH 4 buffer solution, 1 pint (473 ml) bottle
3822-7007	159 001 582	pH 7 buffer solution, 1 pint (473 ml) bottle
3822-7010	159 001 583	pH 10 buffer solution, 1 pint (473 ml) bottle
Mounting		
3-8050.390-3	159 310 116	Retaining nut replacement kit, Black Polypropylene
3-8050-1	159 000 753	Universal mount junction box
3-8050-2	159 000 754	Universal mount junction box w/EasyCal (for submersible applications, use with 3-2751-3 and -4 where 4 to 20 mA is required)
3-9000.392-1	159 000 839	Liquid tight connector kit, NPT (1 connector)
3-9000.392-2	159 000 841	Liquid tight connector kit, PG 13.5 (1 connector)
Other		
5523-0322	159 000 761	Sensor cable (per ft), 3-cond. plus shield, 22 AWG, black/red/white (for use with 2751)
P31515-0P200	159 000 630	Universal Pipe Adapter PVC
P31515-0C200	159 000 631	Universal Pipe Adapter CPVC
P31515-0V200	159 000 459	Universal Pipe Adapter PVDF
7310-1024	159 873 004	24 VDC power supply, 10W, 0.42 A
7310-2024	159 873 005	24 VDC power supply, 24W, 1.0 A
7310-4024	159 873 006	24 VDC power supply, 40W, 1.7 A
7310-6024	159 873 007	24 VDC power supply, 60W, 2.5 A
7310-7024	159 873 008	24 VDC power supply, 96W, 4.0 A

3-2751.099 Rev B (03/18)